

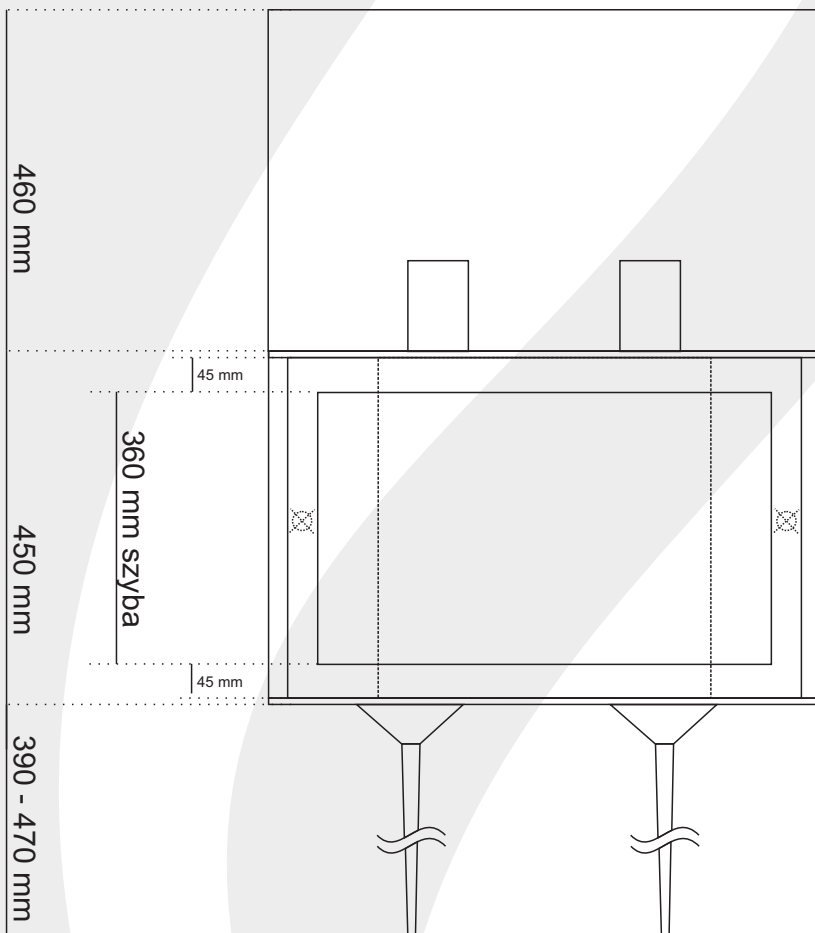

SYSTEMY
KOMINKOWE
WALIGÓRA

SKW-T24

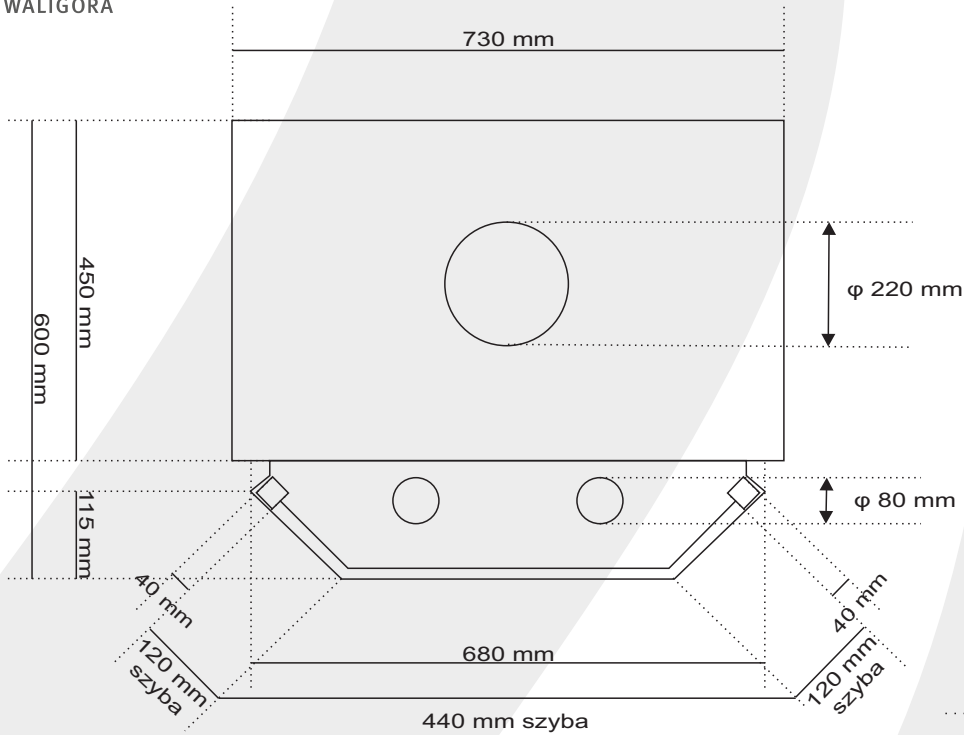

Model:	SKW T24
Moc:	24 KW
Opcje:	L / P / H

Systemy Kominkowe Stanisław Waligóra

NIP: 937 116 22 10, ul. Żywiecka 224, 43-310 Bielsko-Biała, tel./fax 33 814 27 45 tel. 602 818 811
GETIN Bank S.A. o. Bielsko-Biała, nr konta: 20 1560 1023 0000 9020 0006 8285